

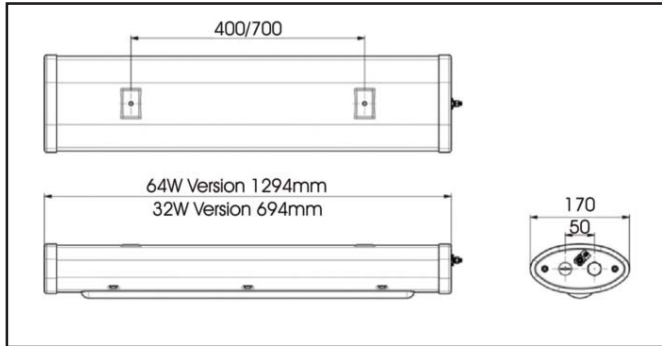

## DuroSite® Stainless Steel LED Linear Luminaire CE Version



### Certifications

- CE - Compliant with EN55015:2006 / EN61547:2009 / EN60598:2008
- IP 66/67 (pending)
- IK09 to EN 50102
- C & D shock compliant to MOD specification BR8470
- RoHS compliant

### Features & Benefits

- L70 rated for >100,000 hours @ 25°C ambient
- 5 year full performance warranty
- Instant on/off operation
- Universal input (110-250V AC) 50/60Hz
- Superior colour rendition index compared to HPS, LPS, MV
- Mercury free
- Resistant to shock and vibration
- Temperature compensation technology for longer life
- Easy retrofit solution for existing fluorescent fittings due to same size and fixing centres
- Factory sealed option available
- Factory safety shackle option available
- Factory fitted wireguard option available

### Application:

The Dialight DuroSite® LED Linear luminaire with its low profile, rugged design ensures long life and high reliability for a wide variety of Industrial applications. Offered in 32W and 64W versions to replicate the light output of typical 2 x 18W & 2 x 36W fluorescent luminaires respectively, Dialight offers a range of mounting options for use with the DuroSite Linear luminaire.

### Mechanical Information

Fixture Weight:	1294mm - 11.4 kg (25.1 lbs) 694mm - 6.5 kg (14.3lbs)
Mounting:	(2) M8 fixing points
Cable Entry:	2 x M20 cable entries at both ends, through wired as standard. Consult factory for other options
Cabling:	Pre-wired cable option available one or both ends or with a junction box /terminal box one or both ends, to suit customer requirements.

### Electrical specifications

Operating Voltage:	110-250V 50/60Hz
Power Consumption:	32W / 64W
Operating Temp:	-20°C to +60°C (-4°F to +140°F)
Noise Requirements/ EMC:	EN 61000-3-2: 2006
THD:	<15% @ 120V AC <20% @ 250V AC
Surge Protection:	EN-61000-4-5 1 kV line to line 2 kV line to ground
Power Factor:	> 0.9

### Photometric Information

CCT:	5,650K (cool white)
CRI:	70 (cool white)
IES Files:	Consult factory

All values typical unless otherwise stated  
All lumen values are typical (tolerance +/- 10%)

## Photometric Information

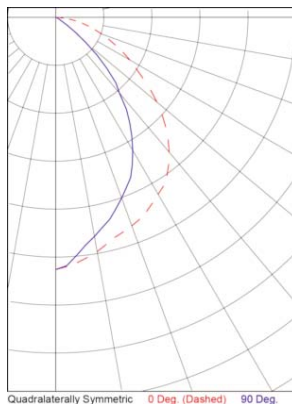





# DuroSite® Stainless Steel LED Linear Luminaire

## Ordering Information

Part Number	Voltage	Colour	Entry Options	Lumens	Watts	Lumens Per Watt
EL-1C3R-SSCB	110 - 250V AC	CW	2 at each end	5,500	64	86
EL-1C3M-SSCB	110 - 250V AC	CW	2 at each end	2,750	32	86

## Mounting Options & Accessories

	Part Number	Description	Kit Includes
	ELX-PC-SS-42	Ø40 - 45mm Range Marine Grade Stainless Steel Pole Clamp	2 x Pole clamp bracket Mounting hardware
	ELX-PC-SS-47	Ø47 - 51mm Range Marine Grade Stainless Steel Pole Clamp	
	ELX-PC-SS-54	Ø54 - 57mm Range Marine Grade Stainless Steel Pole Clamp	
	ELX-PC-SS-59	Ø59 - 62mm Range Marine Grade Stainless Steel Pole Clamp	
	ELX-EYE	Marine Grade Stainless Steel Eyelet kit	2 x M8 Eyelets Mounting Hardware
	ELX-CMB	Marine Grade Stainless Steel Ceiling Mount Kit	Bracket Mounting hardware
	ELX-WMB-SS-30	30° Marine Grade Stainless Steel Wall Mount Kit	Bracket Mounting hardware
	ELX-WMB-SS-45	45° Marine Grade Stainless Steel Wall Mount Kit	
	ELX-WMB-SS-60	60° Marine Grade Stainless Steel Wall Mount Kit	
	ELX-WMB-SS-90	90° Marine Grade Stainless Steel Wall Mount Kit	

## Mounting Options & Accessory Dimensions

### Pole Clamp

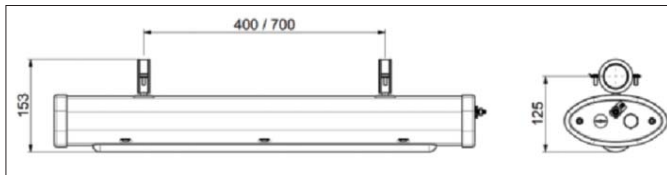

### Eyelet

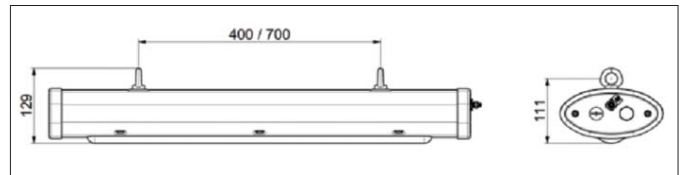

### Ceiling Mount

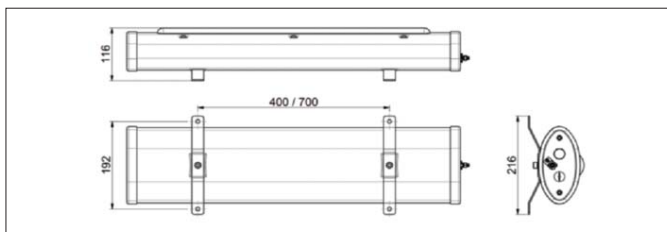

### Wall Mount Bracket 30°

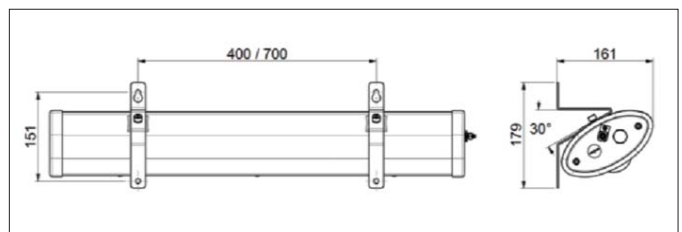

### Wall Mount Bracket 45°

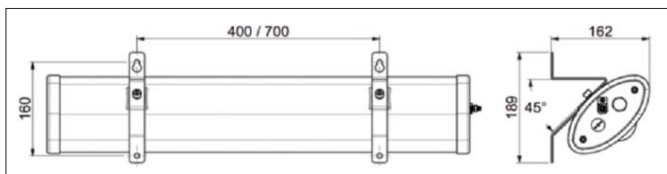

### Wall Mount Bracket 60°

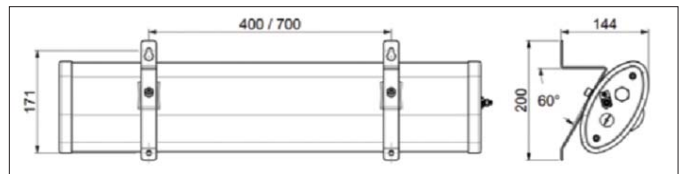

### Wall Mount Bracket 90°

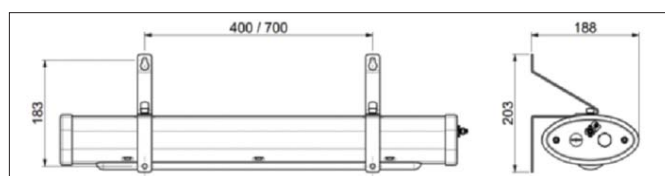

Dialight reserves the right to make changes at any time in order to supply the best product possible. The most current version of this document will always be available at: [www.dialight.com/Assets/Brochures\\_And\\_Catalogs/Illumination/MDTFSFSHZLDSEUX001.pdf](http://www.dialight.com/Assets/Brochures_And_Catalogs/Illumination/MDTFSFSHZLDSEUX001.pdf)  
 Warranty Statement: EXCEPT FOR THE WARRANTY EXPRESSLY PROVIDED FOR [HEREIN/ABOVE/BELOW], DIALIGHT DISCLAIMS ANY AND ALL OTHER WARRANTIES, EXPRESS OR IMPLIED, INCLUDING, WITHOUT LIMITATION, ANY WARRANTIES OF MERCHANTABILITY, FITNESS FOR A PARTICULAR PURPOSE, TITLE, AND NON-INFRINGEMENT.